



100V 3.0mΩ N-Ch Power MOSFET

Features

- Ultra-low $R_{DS(ON)}$
- Low Gate Charge
- 100% UIS Tested, 100% R_g Tested
- Pb-free Lead Plating
- Halogen-free and RoHS-compliant

Product Summary

Parameter	Value	Unit
V_{DS}	100	V
$V_{GS(th)}$	2.7	V
I_D (@ $V_{GS} = 10V$) ⁽¹⁾	190	A
$R_{DS(ON)}$ (@ $V_{GS} = 10V$)	3.0	mΩ

Applications

- Power Management in Telecom., Industrial Automation, CE
- Current Switching in DC/DC & AC/DC (SR) Sub-systems
- Motor Driving in Power Tool, E-vehicle, Robotics

TO-220-3L Top View

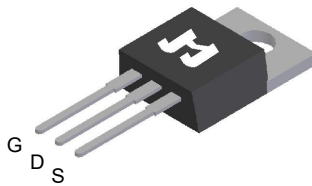

TO-263-3L Top View

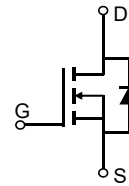
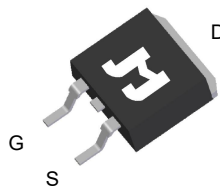

Ordering Information

Device	Package	# of Pins	Marking	MSL	T_J (°C)	Media	Quantity (pcs)
JMSH1004AC-U	TO-220-3L	3	SH1004A	N/A	-55 to 175	Tube	50
JMSH1004AE-13	TO-263-3L	3	SH1004A	3	-55 to 175	13-inch Reel	800

Absolute Maximum Ratings (@ $T_A = 25^\circ C$ unless otherwise specified)

Parameter	Symbol	Value	Unit
Drain-to-Source Voltage	V_{DS}	100	V
Gate-to-Source Voltage	V_{GS}	±20	V
Continuous Drain Current ⁽¹⁾	I_D	$T_C = 25^\circ C$	190
		$T_C = 100^\circ C$	134
Pulsed Drain Current ⁽²⁾	I_{DM}	531	A
Avalanche Current ⁽³⁾	I_{AS}	70	A
Avalanche Energy ⁽³⁾	E_{AS}	245	mJ
Power Dissipation ⁽⁴⁾	P_D	$T_C = 25^\circ C$	250
		$T_C = 100^\circ C$	125
Junction & Storage Temperature Range	T_J, T_{STG}	-55 to 175	°C

$R_{DS(ON)}$ vs. V_{GS}

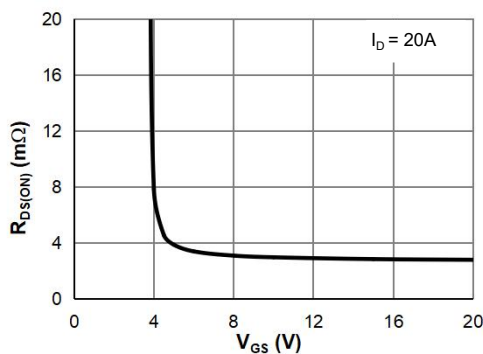

Gate Charge

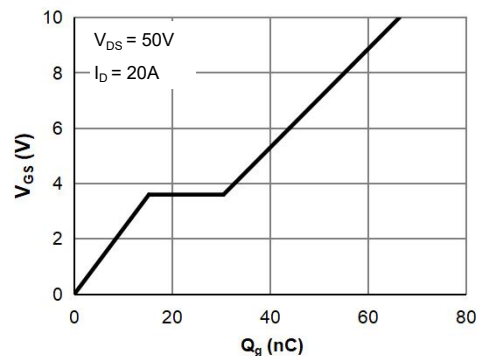



Electrical Characteristics (@ $T_J = 25^\circ\text{C}$ unless otherwise specified)

Parameter	Symbol	Conditions	Min.	Typ.	Max.	Unit
STATIC PARAMETERS						
Drain-Source Breakdown Voltage	$V_{(BR)DSS}$	$I_D = 250\mu\text{A}, V_{GS} = 0\text{V}$	100			V
Zero Gate Voltage Drain Current	I_{DSS}	$V_{DS} = 80\text{V}, V_{GS} = 0\text{V}$ $T_J = 55^\circ\text{C}$			1.0 5.0	μA
Gate-Body Leakage Current	I_{GSS}	$V_{DS} = 0\text{V}, V_{GS} = \pm 20\text{V}$			± 100	nA
Gate Threshold Voltage	$V_{GS(th)}$	$V_{DS} = V_{GS}, I_D = 250\mu\text{A}$	2.0	2.7	4.0	V
Static Drain-Source ON-Resistance	$R_{DS(ON)}$	$V_{GS} = 10\text{V}, I_D = 20\text{A}$		3.0	3.6	$\text{m}\Omega$
Forward Transconductance	g_{FS}	$V_{DS} = 5\text{V}, I_D = 20\text{A}$		85		S
Diode Forward Voltage	V_{SD}	$I_S = 1\text{A}, V_{GS} = 0\text{V}$		0.71	1.0	V
Diode Continuous Current	I_S	$T_C = 25^\circ\text{C}$			250	A
DYNAMIC PARAMETERS ⁽⁵⁾						
Input Capacitance	C_{iss}	$V_{GS} = 0\text{V}, V_{DS} = 50\text{V}, f = 1\text{MHz}$		4398		pF
Output Capacitance	C_{oss}			1361		pF
Reverse Transfer Capacitance	C_{rss}			8.5		pF
Gate Resistance	R_g	$V_{GS} = 0\text{V}, V_{DS} = 0\text{V}, f = 1\text{MHz}$		2.5		Ω
SWITCHING PARAMETERS ⁽⁵⁾						
Total Gate Charge (@ $V_{GS} = 10\text{V}$)	Q_g	$V_{GS} = 0 \text{ to } 10\text{V}$ $V_{DS} = 50\text{V}, I_D = 20\text{A}$		66		nC
Total Gate Charge (@ $V_{GS} = 6.0\text{V}$)	Q_g			44		nC
Gate Source Charge	Q_{gs}			15.2		nC
Gate Drain Charge	Q_{gd}			15.2		nC
Turn-On DelayTime	$t_{D(on)}$	$V_{GS} = 10\text{V}, V_{DS} = 50\text{V}$ $R_L = 2.5\Omega, R_{GEN} = 6\Omega$		17.2		ns
Turn-On Rise Time	t_r			37		ns
Turn-Off DelayTime	$t_{D(off)}$			68		ns
Turn-Off Fall Time	t_f			61		ns
Body Diode Reverse Recovery Time	t_{rr}	$I_F = 20\text{A}, dI_F/dt = 100\text{A}/\mu\text{S}$		94		ns
Body Diode Reverse Recovery Charge	Q_{rr}	$I_F = 20\text{A}, dI_F/dt = 100\text{A}/\mu\text{S}$		242		nC

Thermal Performance

Parameter	Symbol	Typ.	Max.	Unit
Thermal Resistance, Junction-to-Ambient	$R_{\theta JA}$	45	55	$^\circ\text{C}/\text{W}$
Thermal Resistance, Junction-to-Case	$R_{\theta JC}$	0.40	0.60	$^\circ\text{C}/\text{W}$

Notes:

1. Computed continuous current assumes the condition of T_{J_Max} while the actual continuous current depends on the thermal & electro-mechanical application board design.
2. This single-pulse measurement was taken under $T_{J_Max} = 175^\circ\text{C}$.
3. This single-pulse measurement was taken under the following condition [$L = 100\mu\text{H}, V_{GS} = 10\text{V}, V_{DS} = 50\text{V}$] while its value is limited by $T_{J_Max} = 175^\circ\text{C}$.
4. The power dissipation P_D is based on $T_{J_Max} = 175^\circ\text{C}$.
5. This value is guaranteed by design hence it is not included in the production test.

Typical Electrical & Thermal Characteristics

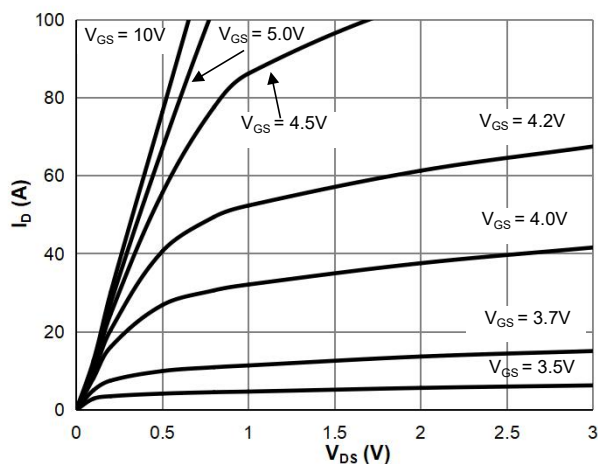

Figure 1: Saturation Characteristics

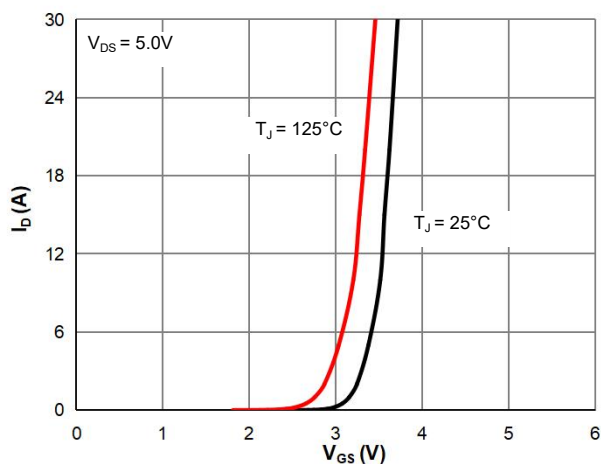

Figure 2: Transfer Characteristics

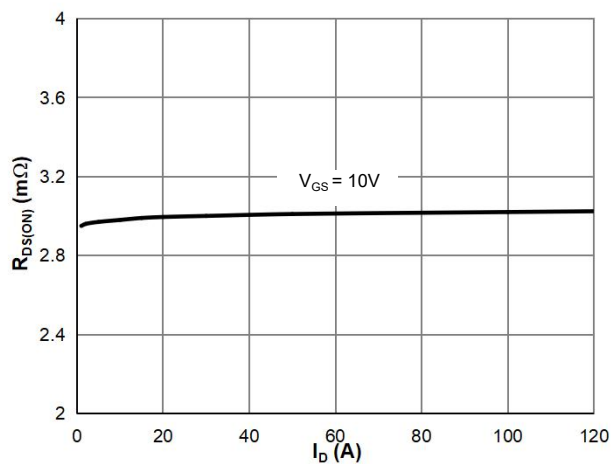

Figure 3: $R_{DS(ON)}$ vs. Drain Current

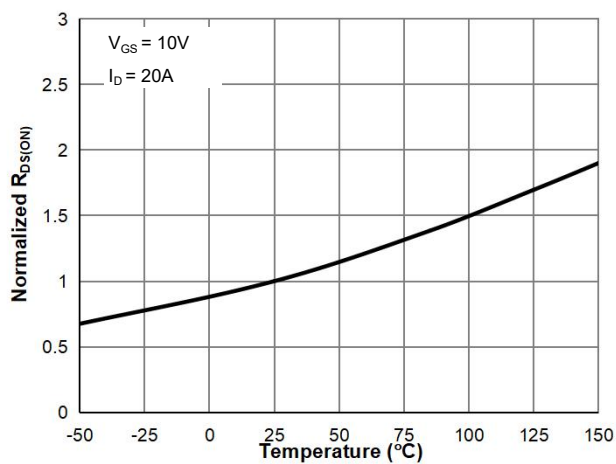

Figure 4: $R_{DS(ON)}$ vs. Junction Temperature

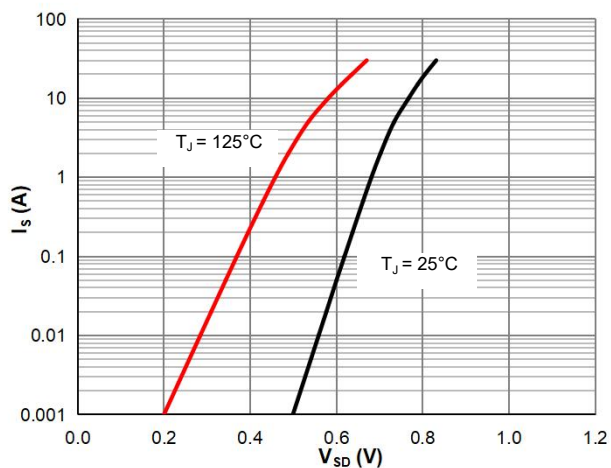

Figure 5: Body-Diode Characteristics

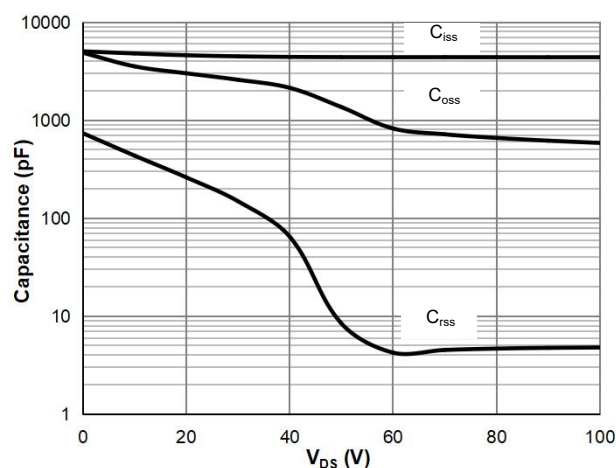

Figure 6: Capacitance Characteristics

Typical Electrical & Thermal Characteristics

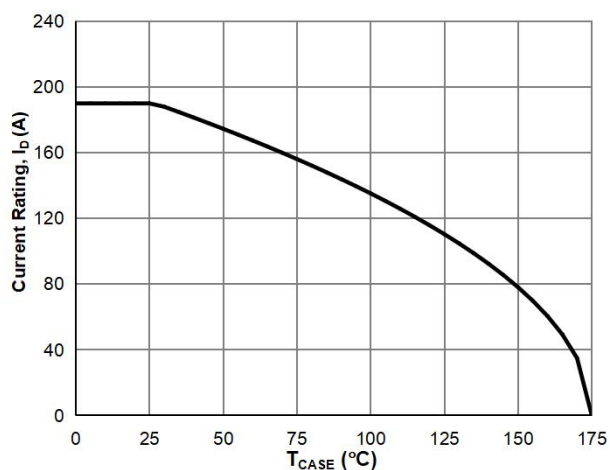

Figure 7: Current De-rating

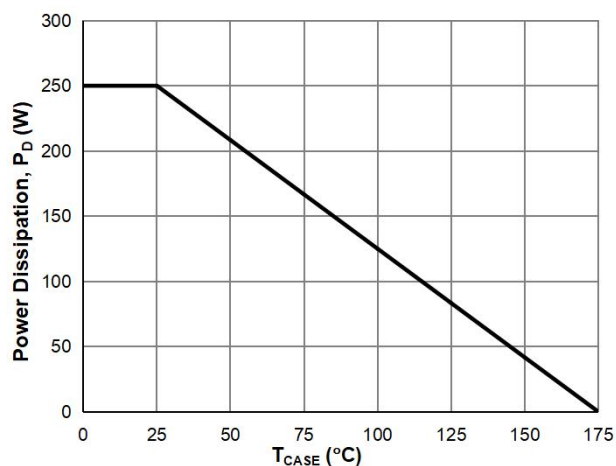

Figure 8: Power De-rating

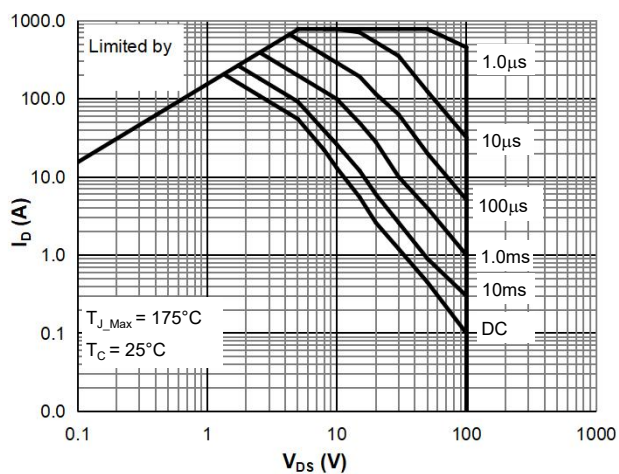

Figure 9: Maximum Safe Operating

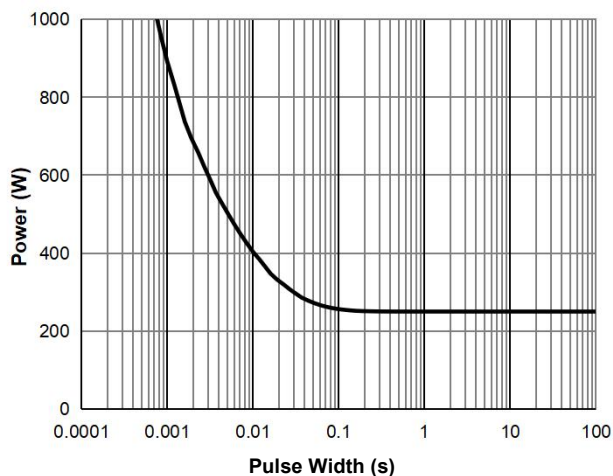

Figure 10: Single Pulse Power Rating, Junction-to-Case

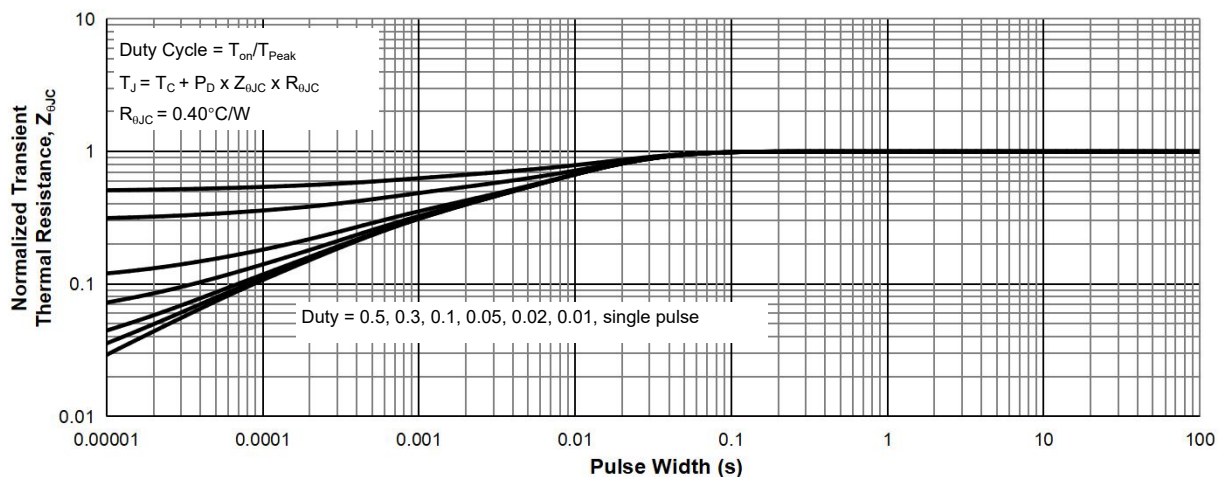
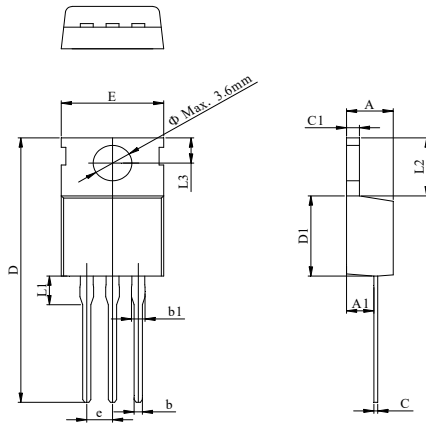

Figure 11: Normalized Maximum Transient Thermal Impedance



TO-220-3L Package Information

Package Outline



DIM.	MILLIMETER		
	MIN.	NOM.	MAX.
A	4.24		4.70
A1	2.20		3.00
b	0.70		0.95
b1	1.14		1.70
C	0.40		0.60
C1	1.15		1.40
D	28.00		29.80
D1	8.80		9.90
E	9.70		10.50
L1			3.80
L2	6.25		6.90
L3	2.40		3.00
e		2.54 BSC	

TO-263-3L Package Information

Package Outline

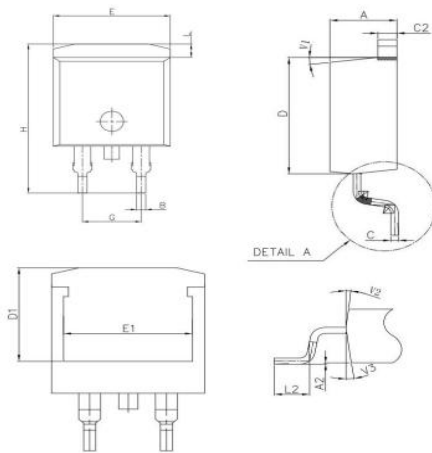

SYMBOL	DIMENSIONS		
	MIN	NOM	MAX
A	4.3	4.55	4.7
A2	0		0.25
B	0.75	0.8	0.85
C	0.38	0.46	0.55
C2	1.25	1.3	1.35
D	8.9	9.3	9.6
D1	7.4	7.65	7.9
E	9.9	10.05	10.21
E1	8.3	8.6	8.9
G	5.03	5.08	5.13
H	14.7	15	15.8
L2	2.2	2.35	2.5

Recommended Footprint

